

I 80A

Peso Kg/m 0.50
Weight Kg/m

Dimension H on request
Dimension L on request

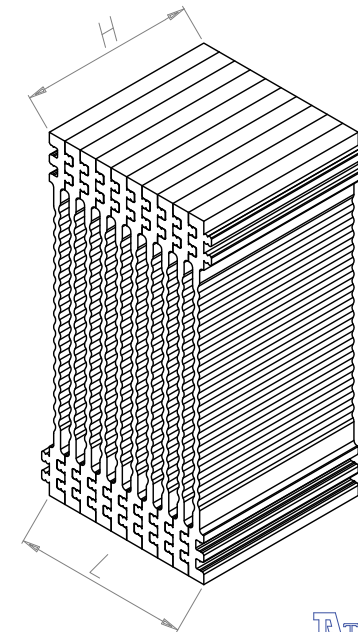
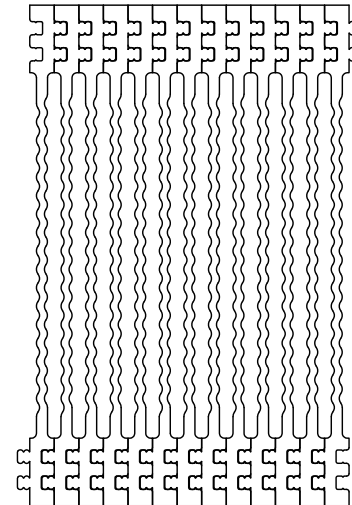
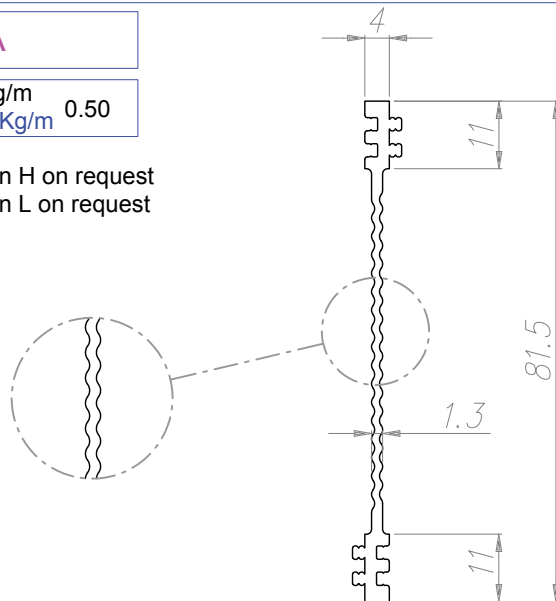

DATA SHEET	PART NUMBER	I 80Ax80/180	I	L	H
			80	80	180

PROVA TEST	CARICO PRINCIPALE MAIN POWER LOAD W	CARICO SECONDARIO MINOR POWER LOAD W	VENTOLA 1 FAN 1 TYPE 80x80x25 DC	VENTOLA 2 FAN 2 TYPE 80x80x25 DC	ΔT °C	RT °C/W	VELOCITA' USCITA ARIA OUTGOING AIR SPEED m/sec	D.D.P. mm H ₂ O
1	225	225	*	*	26.5	0.0589	7.5	
2	225		*	*	17.0	0.0756	7.5	
3	225		*		20.0	0.0889	5.0	2.8
4	225	225	*		33.0	0.0733	5.0	2.8

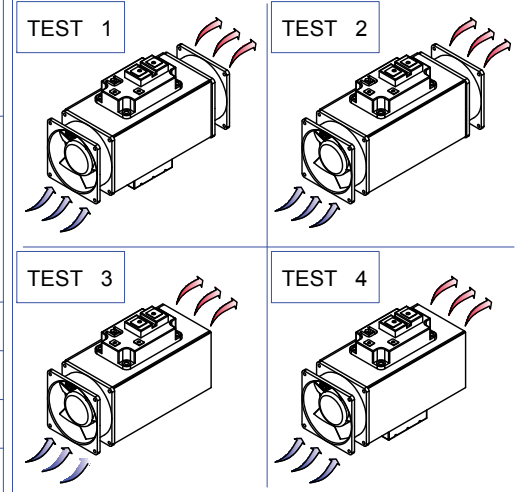

ALL SIZES ARE SUBJECT THE TOLERANCE OF EXTRUSION

TUTTE LE DIMENSIONI SONO SOGGETTE ALLE TOLLERANZE DI ESTRUSIONE

UNLESS OTHERWISE INDICATED, PIECES NOT IN COMPLIANCE WITH THE GENERAL PRESCRIBED TOLERANCES SHOULD NOT AUTOMATICALLY BE REFUSE WHEN THE FUNCTIONALITY OF THE PIECES HAS NOT BEEN COMPROMISED.

SALVO INDICAZIONE CONTRARIA I PEZZI NON CONFORMI ALLE TOLLERANZE GENERLI PRESCRITTE NON DEVONO ESSERE AUTOMATICAMENTE RIFIUTATI QUANDO LA FUNZIONALTA' DEL PEZZO NON RISULTA COMPROMESSA.