

K160

Peso Kg/m  
Weight Kg/m 7.23

Rt °C/W 0.55

Lung. campione mm  
Sample length mm 150

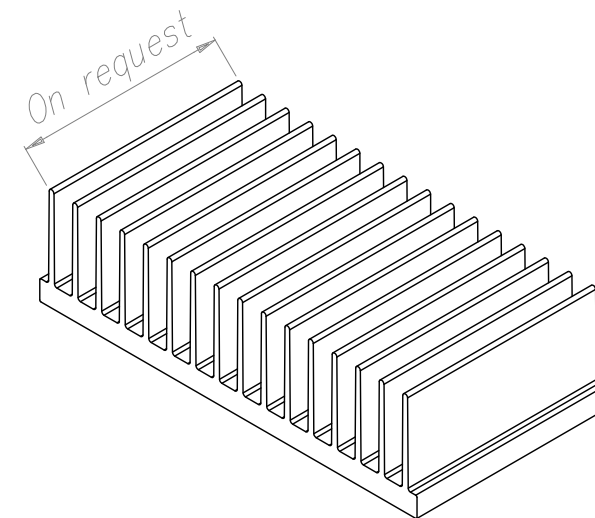
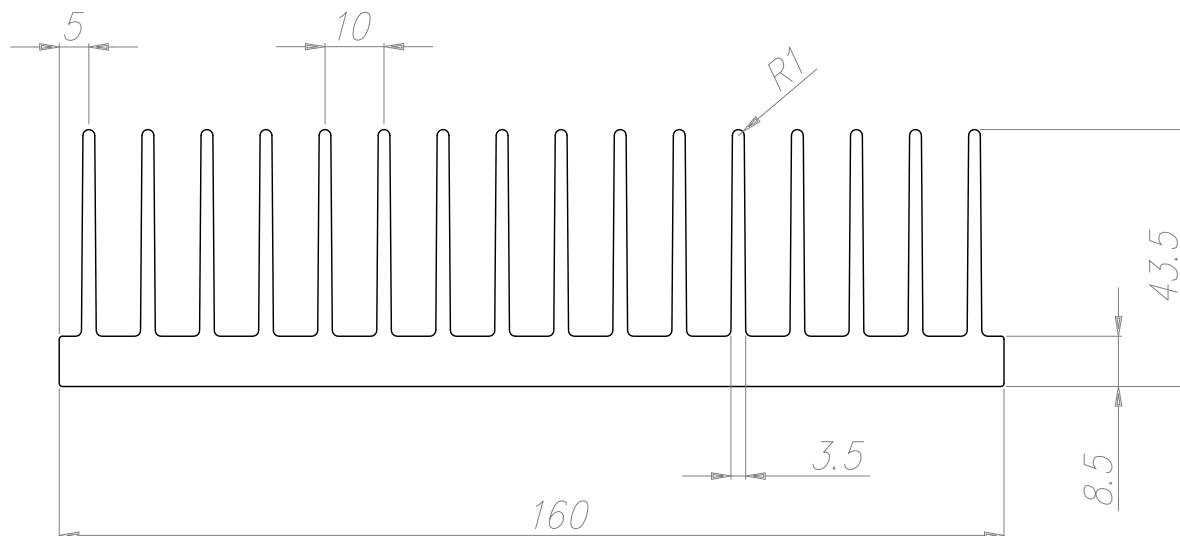

**ALL SIZES ARE SUBJECT THE TOLERANCE OF EXTRUSION**

UNLESS OTHERWISE INDICATED, PIECES NOT IN COMPLIANCE WITH THE GENERAL PRESCRIBED TOLERANCES SHOULD NOT AUTOMATICALLY BE REFUSE WHEN THE FUNCTIONALITY OF THE PIECES HAS NOT BEEN COMPROMISED.

**TUTTE LE DIMENSIONI SONO SOGGETTE ALLE TOLLERANZE DI ESTRUSIONE**

SALVO INDICAZIONE CONTRARIA I PEZZI NON CONFORMI ALLE TOLLERANZE GENERLI PRESCRITTE NON DEVONO ESSERE AUTOMATICAMENTE RIFIUTATI QUANDO LA FUNZIONALTA' DEL PEZZO NON RISULTA COMPROMESSA.

Notes:

-----

-----

-----

-----

-----