

K42

Peso Kg/m
Weight Kg/m

0.95

Rt °C/W 4.2

Lung. campione mm
Sample length mm 100

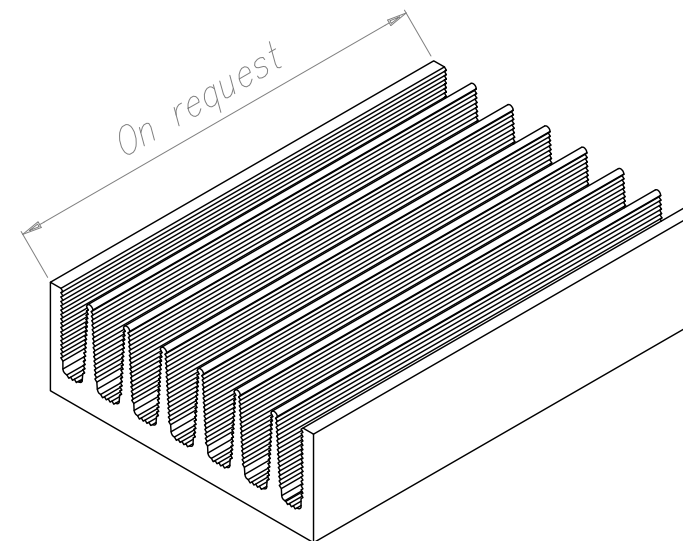
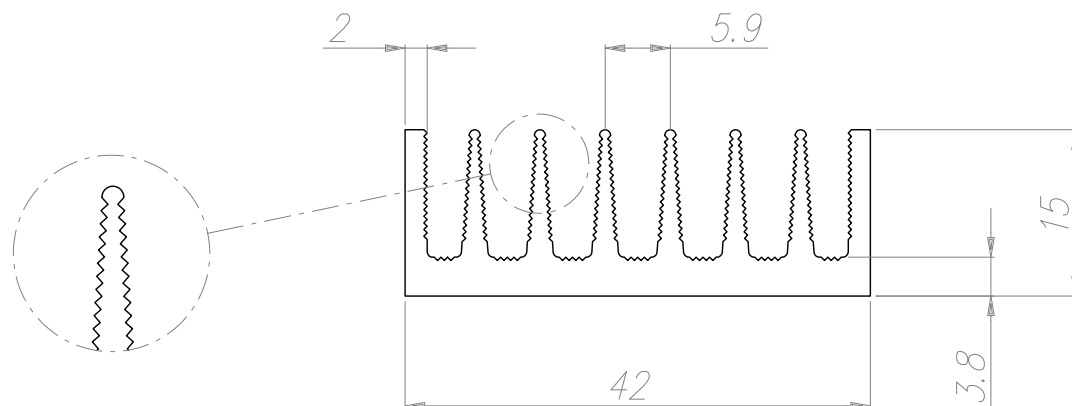

ALL SIZES ARE SUBJECT THE TOLERANCE OF EXTRUSION

UNLESS OTHERWISE INDICATED, PIECES NOT IN COMPLIANCE WITH THE GENERAL PRESCRIBED TOLERANCES SHOULD NOT AUTOMATICALLY BE REFUSE WHEN THE FUNCTIONALITY OF THE PIECES HAS NOT BEEN COMPROMISED.

TUTTE LE DIMENSIONI SONO SOGGETTE ALLE TOLLERANZE DI ESTRUSIONE

SALVO INDICAZIONE CONTRARIA I PEZZI NON CONFORMI ALLE TOLLERANZE GENERLI PRESCRITTE NON DEVONO ESSERE AUTOMATICAMENTE RIFIUTATI QUANDO LA FUNZIONALTA' DEL PEZZO NON RISULTA COMPROMESSA.

Notes:
