

I 125W4C

Peso Kg/m 18.6
Weight Kg/m

Ventilazione forzata
Forced ventilation

Lung. campione mm 300
Sample length mm

Velocità dell'aria in uscita (m/sec) 6.0
Outgoing air speed (m/sec)

Rt °C/W 0.039

Dimension H on request

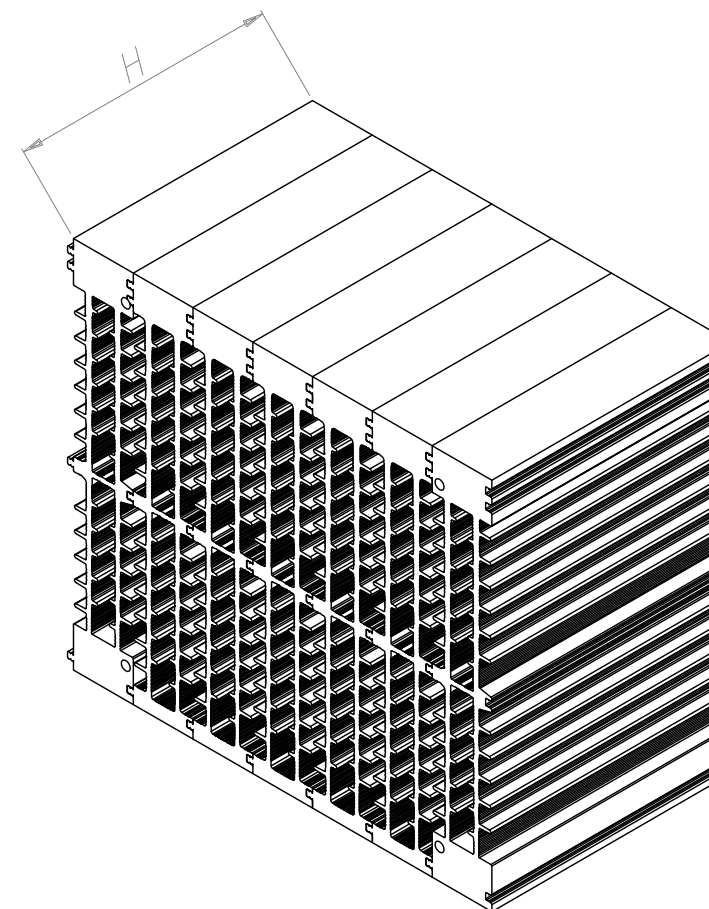
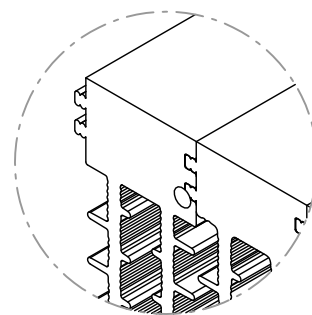
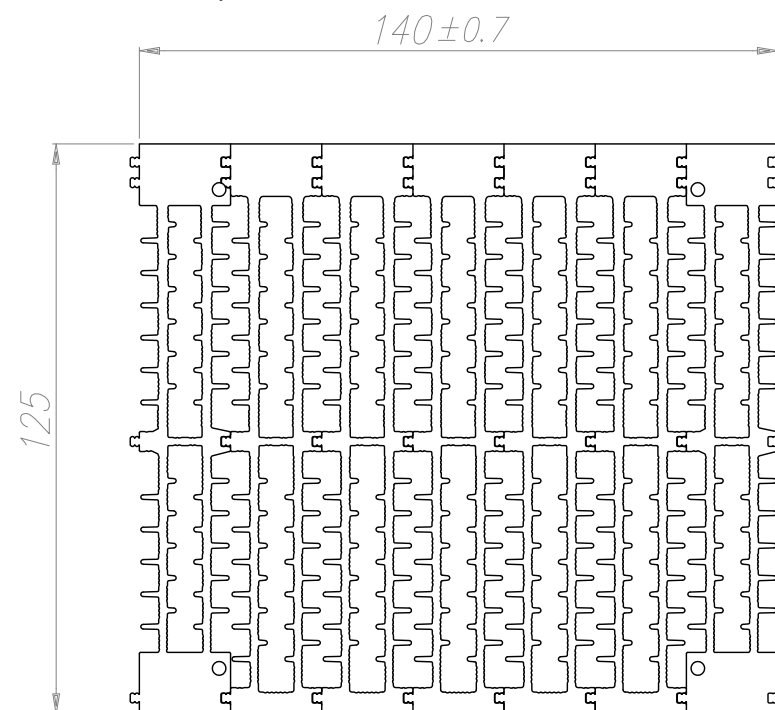

Su richiesta foratura M3x8mm per fissaggio ventola 120x120
On request holes M3x8mm for fan 120x120

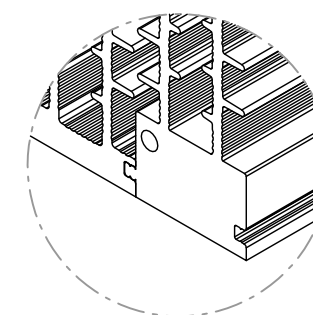
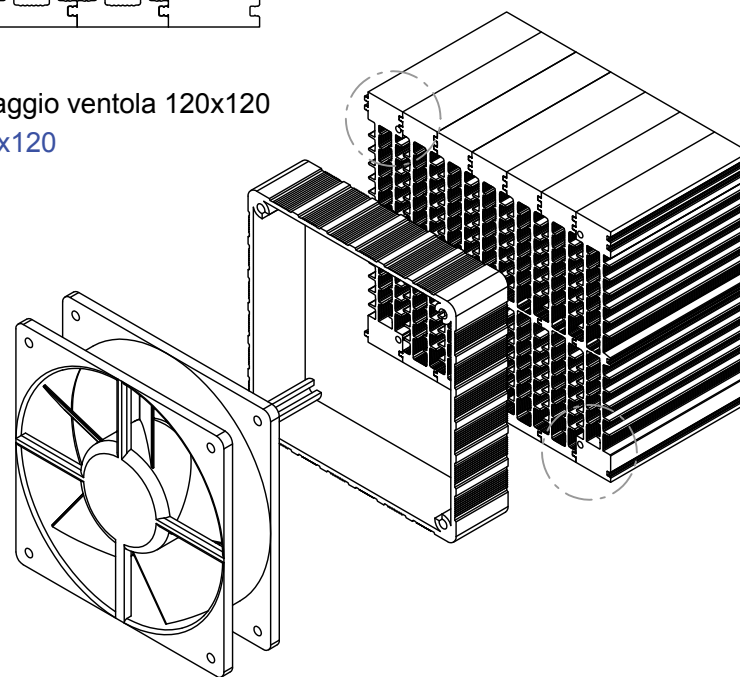

ALL SIZES ARE SUBJECT THE TOLERANCE OF EXTRUSION

UNLESS OTHERWISE INDICATED, PIECES NOT IN COMPLIANCE WITH THE GENERAL PRESCRIBED TOLERANCES SHOULD NOT AUTOMATICALLY BE REFUSE WHEN THE FUNCTIONALITY OF THE PIECES HAS NOT BEEN COMPROMISED.

TUTTE LE DIMENSIONI SONO SOGGETTE ALLE TOLLERANZE DI ESTRUSIONE

SALVO INDICAZIONE CONTRARIA I PEZZI NON CONFORMI ALLE TOLLERANZE GENERLI PRESCRITTE NON DEVONO ESSERE AUTOMATICAMENTE RIFIUTATI QUANDO LA FUNZIONALTA' DEL PEZZO NON RISULTA COMPROMESSA.

Notes:
